

INSTALLATION *guide*



inteo *SOLIRIS receiver RTS*

The SOLIRIS receiver RTS is a radio receiver for awnings with an automatic control according to the daylight intensity and protection against wind damage.

The SOLIRIS receiver RTS has to be used with the TELIS soliris RTS and the SOLIRIS sensor.

The SOLIRIS receiver RTS is also compatible with the other RTS controls and the INIS RT (the functioning is a trip switch type : ▲, stop, ▼, stop,...) Commands are transmitted by radio (frequency 433.42 MHz).

1 Characteristics:

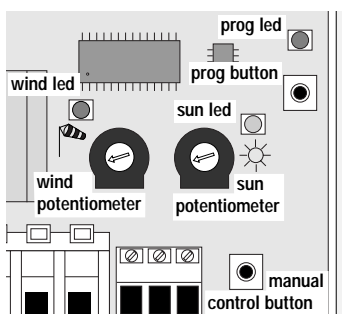
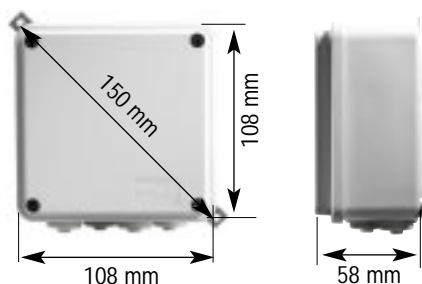

- Mains supply : 220-240 V~ 50/60 Hz
- Protection index: IP 44
- Operating temperature: -20°C to +50°C
- Class II product once installed
- Normally polluted environment

2 Installation:

Before connecting the unit, you must read the instructions carefully.

A Mounting of the SOLIRIS receiver RTS :

The SOLIRIS receiver RTS is compatible with all standard SOMFY motors. Cabling arrangements are shown in the diagram.

Respect the electrical standards in force as well as the following points:

- disconnect the mains before carrying out any work.
- Install the SOLIRIS receiver RTS with the cables entry pointing downwards to avoid water infiltration.
- Do not install the SOLIRIS receiver RTS against a metallic part (it could affect the radio transmission).
- minimum distance between the receiver and the floor : **1,5 m.**
- minimum distance between the receiver and the roof : **30 cm.**
- minimum distance between the receiver and the transmitter : **30 cm.**
- minimum distance between two receivers : **20 cm.**

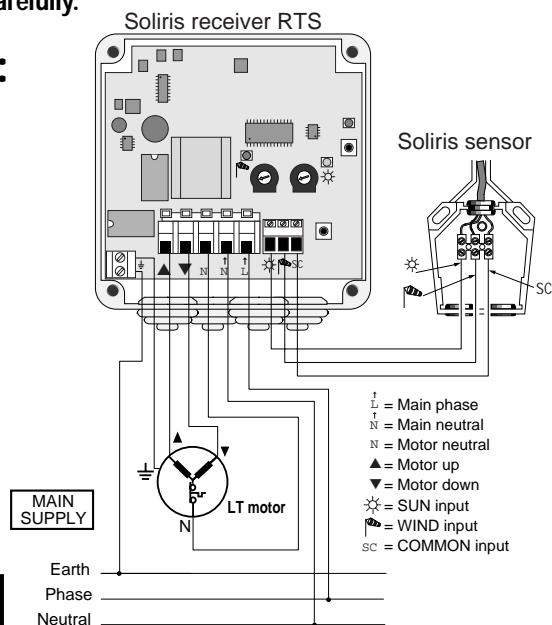

PRINCIPLE DIAGRAM

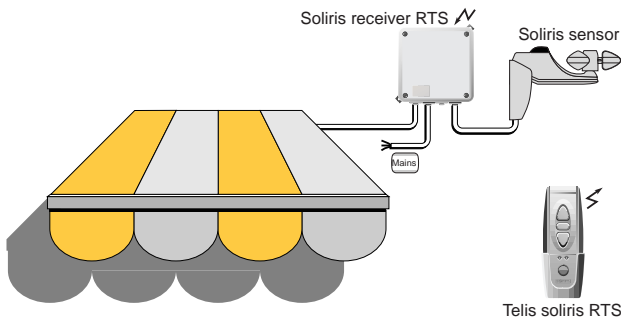

MOUNTING OF THE SOLIRIS SENSOR

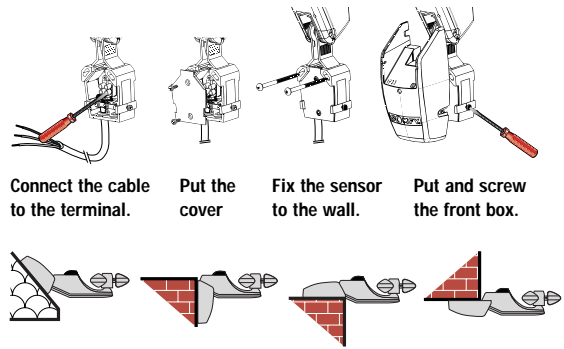

B Programming :

1 INITIAL INSTALLATION

with an RTS control (TELIS soliris RTS ; Centralis RTS ; TELIS 1 or 4 RTS).

Set the SOLIRIS receiver RTS in its programming mode by pressing the PROG button until the LED lights.

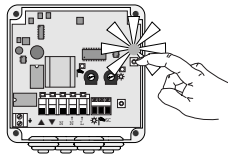

This indicates that the SOLIRIS receiver RTS is ready to receive the address of a control for one minute (After this time limit, the LED will go out).

Press **shortly** the programming button on the RTS control.



The LED of the SOLIRIS receiver RTS blinks indicating that the address of the RTS control is

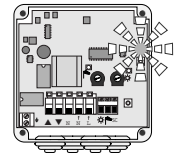

memorized in receiver which automatically quits its programming mode.

MULTIPLE CONTROL

• Assign several RTS controls to the SOLIRIS receiver RTS following the same procedure as described above.

You can assign up to 16 controls to one receiver. If you try to enter a 17th, your instruction will be ignored, the led of the receiver will go out.

GENERAL OR GROUP CONTROL

• Set all the SOLIRIS receiver RTS you wish to control by one RTS control in their programming mode.

• Press **shortly** the programming button of the RTS control.

⇒ The LEDs of all the SOLIRIS receiver RTS blink indicating that the address of the RTS control is memorized in all these receivers.

with an INIS RT.

**you can only program one INIS RT in the memory of a receiver (single control).
you cannot program INIS RT and RTS controls together in the memory of a receiver.**

Set the SOLIRIS receiver RTS in its programming mode by pressing the PROG button until the LED lights.

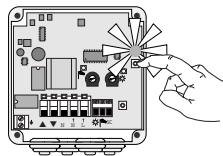

This indicates that the SOLIRIS receiver RTS is ready to receive the address of a control for one minute (After this time limit, the LED will go out).

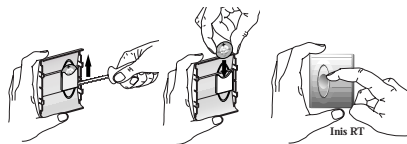

Remove and replace the battery of the INIS RT, then Press **shortly** the push button on the INIS RT.

The LED of the SOLIRIS receiver RTS blinks indicating that the address of the INIS RT is memorized in receiver which automatically quits its programming mode.

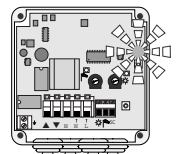

2 ADD A NEW CONTROL IN THE MEMORY OF A RECEIVER (ONLY WITH RTS CONTROL)

Press more than 2 seconds on the programming button of a RTS control which is already memorized in the SOLIRIS receiver RTS in order to "wake up" the SOLIRIS receiver RTS.

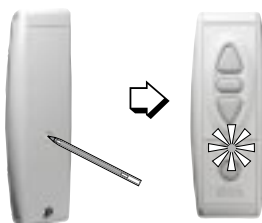

⇒ the LED of the RTS control lights on, indicating that all the SOLIRIS receivers RTS which have the address of this control are in their programming mode for one minute.

Press **shortly** the programming button of the new RTS control you wish to assign.

⇒ The address of this control is memorized in all the SOLIRIS receivers RTS which automatically quit their programming mode.

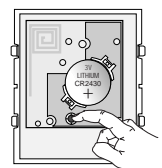

3 REMOVE A RTS CONTROL FROM THE MEMORY OF THE RECEIVER (ON AN EXISTING INSTALLATION)

To remove a RTS control from the memory of a RTS receiver, set the SOLIRIS receiver RTS in its programming mode, then press shortly the prog button of the RTS control you wish to remove.

It is also possible to "wake up" the SOLIRIS receiver RTS with another RTS control (see § C/2), then press shortly the prog button of the RTS control you wish to remove.

4 REMOVE ALL THE CONTROLS FROM THE MEMORY OF THE RECEIVER (RESET OF THE SOLIRIS RECEIVER RTS)

To remove the addresses of all the controls from the memory of a SOLIRIS receiver RTS, press the programming button of the SOLIRIS receiver RTS until the LED blinks.

⇒ The memory of the receiver is erased.

C Intermediate position (WITH A RTS CONTROL ONLY)

With the SOLIRIS receiver RTS and a RTS control, it is possible to set one or two intermediate positions (IP) : one accessible from the top of the awning and one from the bottom.

The both intermediate positions (IP1 ; IP2) can be reached manually (with a RTS control)

The "top" intermediate position (IP1) can be reached automatically (with the sun detection).

To record these positions, the SOLIRIS receiver RTS has to record the time for the awning to go from its top to the IP and also the time from its bottom one to the IP.

RECORD THE INTERMEDIATE POSITION FROM THE TOP OF THE AWNING (IP1)

Set the awning at its UP limit with the RTS control.

Push simultaneously on the DOWN and IP button of the RTS control until the awning begins to move (about 3 sec).

Stop the awning at the intermediate position you wish with the RTS control (if necessary, adjust this position with ▲ and ▼ push buttons).

Push the IP button of the RTS control during two seconds.
⇒ The SOLIRIS receiver RTS has memorized the 1st intermediate position.

RECORD THE INTERMEDIATE POSITION FROM THE BOTTOM OF THE AWNING (IP2)

Set the awning at its DOWN limit with the RTS control.

Push simultaneously on the UP and IP button of the RTS control until the awning begins to move (about 3 sec).

Stop the awning at the intermediate position you wish with the RTS control (if necessary, adjust this position with ▲ and ▼ push buttons).

Push the IP button of the RTS control during two seconds.
⇒ The SOLIRIS receiver RTS has memorized the 2st intermediate position.

REACH THE INTERMEDIATE POSITIONS

MANUALLY

To reach one of the intermediate positions, set the awning is at its UP (for IP1) or DOWN (for IP2) limit, then press briefly the IP button of the RTS control.

⇒ The awning will move and stop at the dedicated intermediate position.

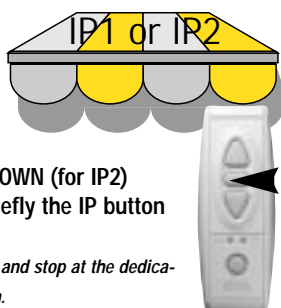

AUTOMATICALLY

When the daylight intensity exceed the threshold set on the SOLIRIS receiver RTS, the awning moves up to the top intermediate position.

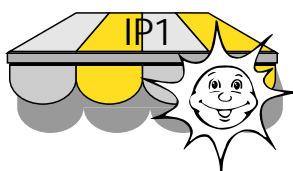

DELETE AN INTERMEDIATE POSITION

To delete an intermediate position, press briefly the IP button of the RTS control to reach the intermediate position you wish to delete, then press continuously the IP button of the control until the led stops blinking (approx. 8 sec.).

⇒ The concerned IP is deleted.

D Wind/Sun function :

The SOLIRIS receiver RTS is able to control and protect an awning regarding the SUN and the WIND.

The WIND and SUN thresholds can be adjusted by a potentiometer to accommodate wind speed and daylight intensity. between 10 to 50 Km/h for the WIND and between 0 to 50 Klux for the SUN.

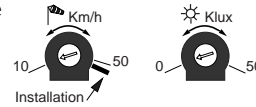

By using the TELIS SOLIRIS RTS, it is possible to configure the functioning of the SOLIRIS receiver RTS.

- ☐ (wind) : the receiver reacts in accordance with the wind information and with the manual UP/DOWN/STOP commands.
- ☐☐ (wind-sun) : the receiver reacts in accordance with the wind, the sun and with the manual UP/DOWN/STOP commands.

Press continuously the select button of the **TELIS SOLIRIS RTS** (approx. 2sec) in order to change the configuration mode of the **SOLIRIS receiver RTS** (please refer to the TELIS SOLIRIS RTS installation guide).

SUN FUNCTION

When the intensity of the daylight exceeds the threshold set by the SOLIRIS receiver RTS, the yellow LED lights after 2 minutes and a DOWN order is given to the motor.

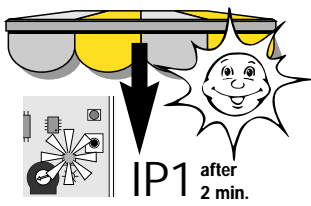

The awning goes to the intermediate position IP1 (see §C) or to its down end limit position if no intermediate position has been memorised.

As long as the level of the daylight exceed the threshold limit, the yellow LED



remains on. When the daylight level falls below the threshold setting, a time delay between 15 to 30 minutes (according to the sun presence duration) is activated and the yellow LED blinks.

After this time delay, an UP order is given to the awning and the LED stops blinking.

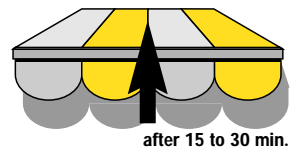

Any manual command given during this cycle will override the automatic operation. The SOLIRIS receiver RTS will not then function automatically until the daylight exceeds the threshold limit again.

WIND FUNCTION

When the wind speed exceeds the threshold set by the SOLIRIS receiver RTS, the red LED lights after 2 seconds and an UP order is given to the awning.

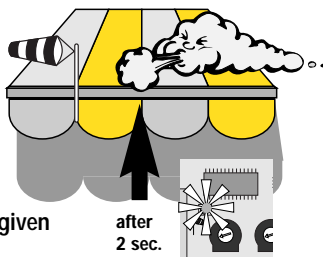

As long as the measured wind speed is higher than the adjusted threshold, the red LED remains on and any order is inhibited (manual control or automatic control).

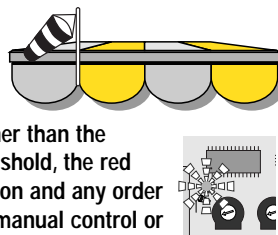

When the wind speed falls below the threshold setting, the red LED blinks.

The SUN function will remain inhibited during 12 min, but after 30 seconds, an order can be given with the RTS control.

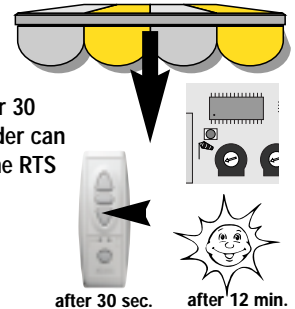

INSTALLATION / COMMISSIONING MODE

In this mode all delay times are reduced to ease installation and the wind threshold is 10Km/h. The mode is selected by turning the wind potentiometer clockwise to the limit.

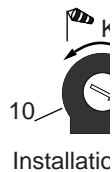

Στέιος Αντ & ΣΙΑ Ο.Ε
 Ρολά Γκαρζόπορτες -Αντικαταστάσεις Ανακαινήσεις Ειδικοί στην Ολική ασφάλεια
 Αμαλιάδος 4 Μεταμόρφωση Τηλ 210 8071281 & 210 8071224 Fax 210 8071768
 e mail info@thyres.gr & thyres@thyres.gr

Diagnosis

The LED on the RTS control does not light.

Check the battery of the RTS control.

The leds of the RTS control lights, but the motor does not operate.

- 1- Press the built-in manual push-button of the SOLIRIS receiver RTS.
- 2- Check the programming.
- 3- Check the good wiring of the motor and the SOLIRIS receiver RTS.

